

# Balanced 2-way Control Valves type M1FB

## Cast iron, PN 16, DN 25 – 80 mm

2.3.03-F

GB-1

### Characteristics

- Pressure balanced
- Single seated, tight closing
- Quadratic valve characteristic
- Regulating capability  $\frac{k_{vs}}{k_{vr}} > 25$

### Applications

The pressure balanced control valves type M1FB are designed for regulating low and medium pressure hot water, steam and lubricating liquids, where the system pressure and the valve size makes it necessary to choose a balanced valve in order to be able to use a single seated valve, which means less leakage.

The valves are installed combined with one of our temperature regulators in control systems for heating of domestic premises, district heating, industrial processes or marine installations.

### Dimensioning

For sizing of control valves and selection of actuators, please see "Quick Choice" leaflet no. 9.0.00.

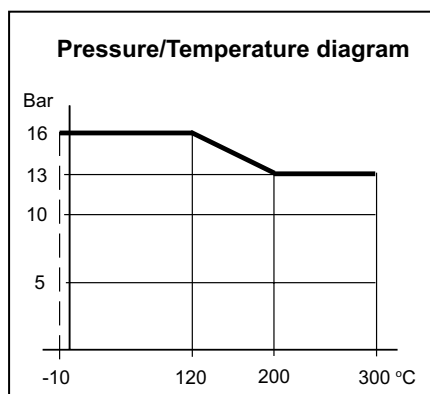

### Design

The valve components - spindle, seat, cone and bellows - are made of stainless steel.

The bellows for balancing the pressure is fitted on the valve spindle and it reduces the power necessary for closing the valve, as the upstream pressure of the medium through the hollow valve spindle acts outside and the pressure after the valve acts inside the bellows system.

The valve body is made of cast iron EN-GJL-250 with connection flanges drilled according to EN 1092-2.

The connection thread for the actuator is ISO 228 - G1B.

The valves are single-seated and, by design, tight closing. The leakage is less than 0.05% of full flow (see VDI/VDE 2174).

### Function

Without an actuator being connected, the valve is held in open position by means of a spring and the bellow system. With pressure on the spindle the valve will close.

In connection with our thermostats or electronic actuators, the valves will close at rising temperatures. For cooling circuits a reverse acting valve can be used.

The quadratic characteristic will not cease until the flow has dropped below 4% of the full flow.

### Quality assurance

All valves are manufactured under an ISO 9001 certification and are pressure and leakage tested before shipment. For marine applications the valves can be supplied with relevant test certificates from recognized classification societies.

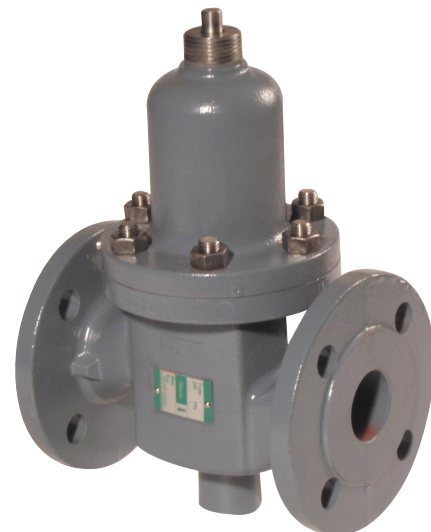

### Technical data

Materials:

- Valve body Cast iron

EN-GJL-250

- Components Stainless steel

- Bolts, nuts 24 CrMo 4/A4

Nominal pressure PN 16

Seating Single seated

Valve characteristic Quadratic

Regulating capability  $\frac{k_{vs}}{k_{vr}} > 25$

Function Closing with pressure on spindle

Leakage  $\leq 0.05\%$  of  $k_{vs}$

Temperature range See pressure/temperature diagram

Mounting See page 2

Flanges EN 1092-2 PN 16

Subject to changes without notice.

Specifications						
Type	Flange connection DN in mm	Opening mm	$k_{vs}$ -value m <sup>3</sup> /h	Lifting height mm	Weight kg	
25 M1FB	25	25	7.5	7	6	
32 M1FB	32	32	12.5	8	9	
40 M1FB	40	40	20	9	13	
50 M1FB	50	50	30	10	16	
65 M1FB	65	65	50	13	23	
80 M1FB	80	80	80	16	38	

# Balanced 2-way Control Valves type M1FB

## Cast iron, PN 16, DN 25 – 80 mm

2.3.03-F

GB-2

### Definition of $k_{VS}$ -value

The  $k_{VS}$ -value is identical to the IEC flow coefficient  $k_V$  and defined as the water flow rate in  $m^3/h$  through the fully open valve by a constant differential pressure,  $\Delta p_V$  of 1 bar.

### Mounting

The valves should be installed with vertical spindles in order to reduce wear and tear. For valve temperatures of **max.** 170°C, the thermostat/actuator can be fitted below or above the valve.

For valve temperatures **above** 170°C, a cooling unit of type KS has to be applied with connection downwards according to the following instructions:

Valve Temperature	Cooling Unit	Suitable for
170°C - 250°C	KS-4	All actuators
250°C - 300°C	KS-5	Thermostats
250°C - 300°C	KS-6	Valve Motors

KS-5 or KS-6 must be applied to hot oil systems.

### Strainer

It is recommended to use a strainer in front of the control valve if the liquid contains suspended particles.

### Accessories

#### Manual Adjusting Device

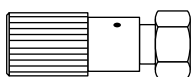

The device has a built-in stuffing box. For tightening and manual operation of valves when an actuator has not been fitted, e.g. during periods of construction.

#### Cooling Unit KS-4

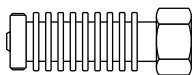

Cooling Unit protecting the stuffing box of the motor/thermostat. To be applied at valve temperatures between 170°C and 250°C.

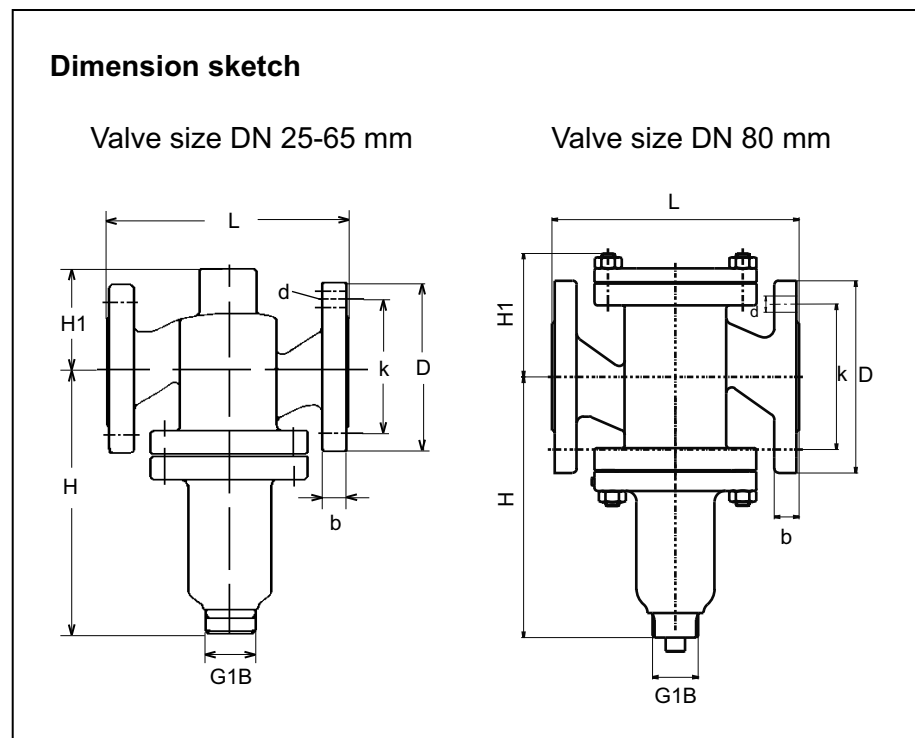

Dimensions							
Type	L mm	H mm	H1 mm	b mm	D (dia.) mm	k (dia.) mm	d mm dia. (number)
25 M1FB	160	180	70	16	115	85	14x(4)
32 M1FB	180	195	75	18	140	100	18x(4)
40 M1FB	200	205	85	18	150	110	18x(4)
50 M1FB	230	225	95	20	165	125	18x(4)
65 M1FB	290	260	110	20	185	145	18x(8)
80 M1FB	310	275	115	22	200	160	18x(8)

#### Cooling Unit KS-5

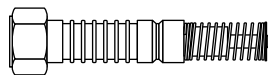

Cooling units with built-in bellow glands, replacing stuffing box of thermostat (KS-5) or valve motor (KS-6). Must be applied at valve temperatures above 250°C and in hot oil systems, regardless the temperature of oil.

#### Cooling Unit KS-6

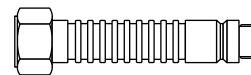

Subject to changes without notice.